

Article number: 03706014

Description: Fluro rod end BRF 14  
with ball bearing

## Measures

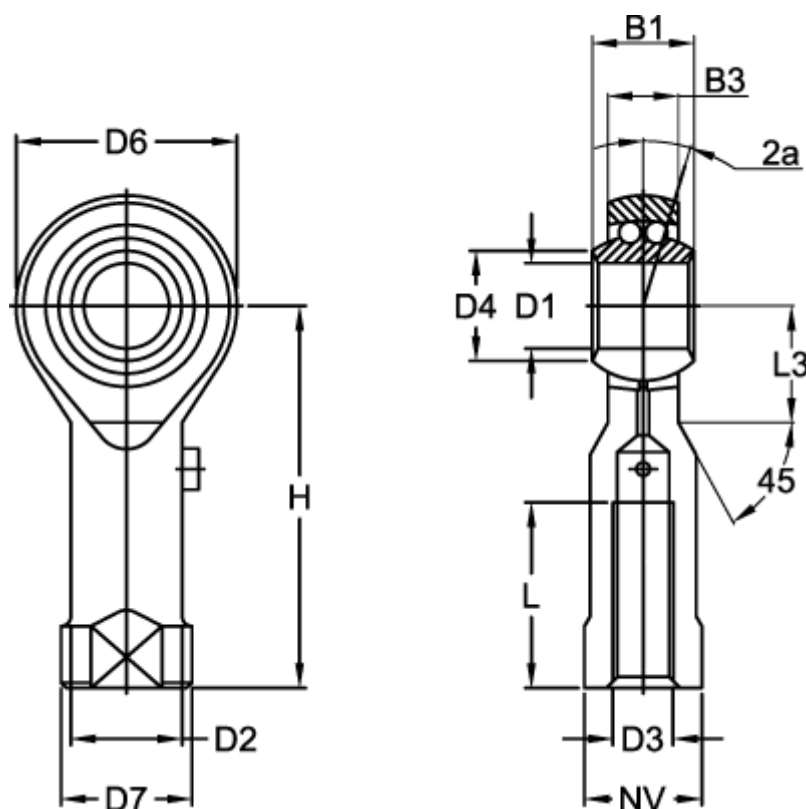

Angel 2a = 6.0	D7	= 25
B1 = 19	Dynamic load C (N)	= 5600
B3 = 13.50	H	= 57
D1 = 14	L	= 25
D2 = 20.0	L3	= 20
D3 = M14x2	Max rpm	= 1025
D4 = 17.0	NV	= 22
D6 = 36	Static load (N)	= 2000

Weight (kg) = 0.160